

havuz örtüsü toplayıcısı
havuz çevresi koruyucu parmaklık
cover rollers
fences for swimming pool

2018
Fiyat Listesi-Price List



NOZBART®

TÜM

PLASTİK VE MAKİNA KALIP SANAYİ VE TİCARET LİMİTED ŞİRKETİ

**TÜV
CERT**
DIN EN ISO 9001:2008
Zertifikat 15 100 52993

TSE

PG

CE

UHE
ULUSLARARASI HAVUZ MÜHÜRLEME
* UHE Kurucu Üyesidir.*

HAVUZ ÇEVRESİ KORUYUCU PARMAKLIK
FENCES FOR SWIMMING POOL

NEW



1,5 m. Parmaklık modülü
1,5 m. Fence module

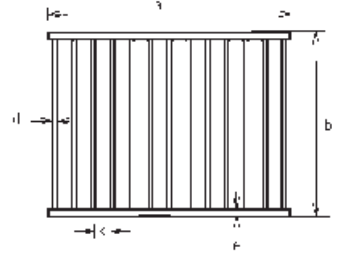

Cod.	€	a	b	c	d	e	Kg	m ³
87183030	352,00	1500	1143	100	Ø18	Ø43	45	1,753

NEW



Parmaklık direği
Posts fence module

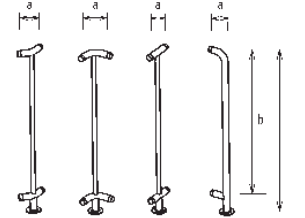

Cod.	€	Desc.	a	b	c	Kg	m ³
87183010	298,00	45°	78+78	1143	1236	4,5	0,0625
87183011	303,00	90°	104+104	1143	1236	5	0,0625
87183012	284,00	180°	162	1143	1236	4,5	0,0625
87183013	275,00	Final	100	1143	1236	5	0,0625

Ölçüler mm - Measures in mm

Duvar sabitleyicisi / Wall fixation

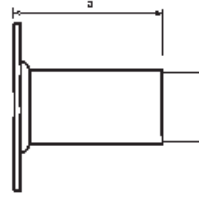

NEW



Cod.	€	a	Kg	m ³	U
87183020	71,00	73	2,5	0,0225	x2

Ölçüler mm - Measures in mm

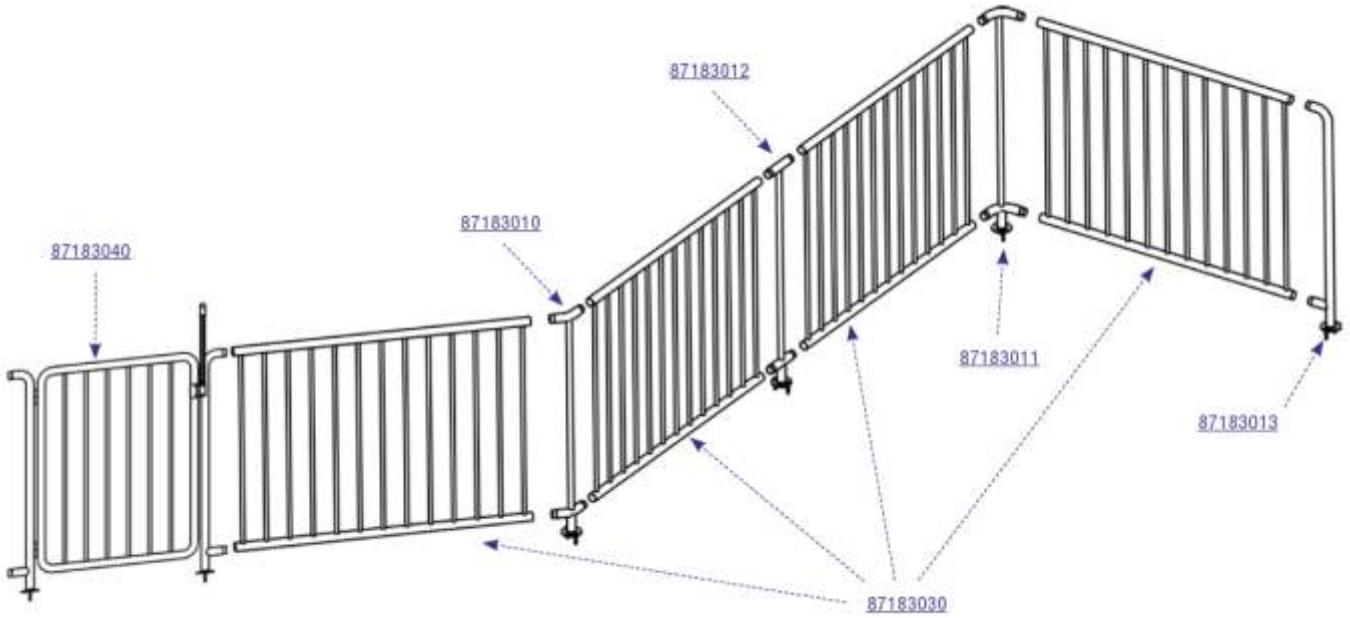

HAVUZ ÖRTÜSÜ TOPLAYICISI
COVER ROLLERS



Hareketli destekli toplayıcı / *Movable support*

Ayak (Tekerlekli)

- ✓ Yükseklik / Height : 500 mm
- ✓ Kutuda 1 adet tekerlekli 1 adet sabit ayak mevcut / İki manivela takılabilir
- ✓ Box contains two supports (With wheel and without wheel) / Possibility of installing two cranks

Cod.	€		Kg	m ³
87197021	219,00	2 Adet	6	0,09

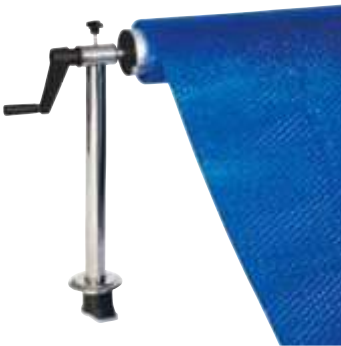

Gömmeli destekli havuz örtüsü toplayıcı / *Support to built-in*

- ✓ Yükseklik / Height : 500 mm
- ✓ Kutuda 2 adet gömmeli ayak mevcut / İki manivela takılabilir
- ✓ Box contains two supports / Possibility of installing two cranks



Ayak (Gömmeli) / *Foot (Built in)*

Cod.	€		Kg	m ³
87197023	173,00	2 Adet	4	0,015

HAVUZ ÖRTÜSÜ TOPLAYICISI COVER ROLLERS

Teleskopik boru gövdesi / Telescopic tube

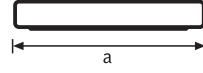

✓ Manivela ve sabitleme kemeri dahil / Crank and fixing strips included

Cod.	€	Sabitleme Kemer Fixing Strips	∅	a	Kg	m ³
87197011	339,00	4	110	2500-4500	18	0,087
87197012	435,00	6	110	4300-5700	29	0,139
87197013	480,00	8	110	5300-6900	35	0,167



Sabitleme kemeri / Fixing strips

NEW

Cod.	€	Kg	m ³	U
87197041	6,20	0,21	0,00086	x4



U : Paket Adedi / Units per package

Havuz Örtüsü Toplayıcısı Parçalarının Montajlı Şematik Görünümü Schematic of Pool Cover Rollers Parts

- 87197011 Teleskopik boru / Telescopic tube (2500- 4500mm) 339,00€
- 87197012 Teleskopik boru / Telescopic tube (4300- 5700mm) 435,00€
- 87197013 Teleskopik boru / Telescopic tube (5300- 6900mm) 480,00€
- 87197021 Hareketli Ayak / Movable support (219,00€)
- 87197022 Flaşlı ayak / Support with flange (181,00€)
- 87197023 Gömmeli ayak / Support to build-in (173,00€)
- 87197031 Manivela / Crank (56,50 €)
- 87197032 Tekerlek / Wheel (44,60 €)
- 87100236 Lastik ayak / Rubber bumper (3,60 €)
- 87197041 Sabitleme kemeri / Fixing strips (6,20 €)
- 87197051 Sabitleme vidası / Brake (6,80 €)

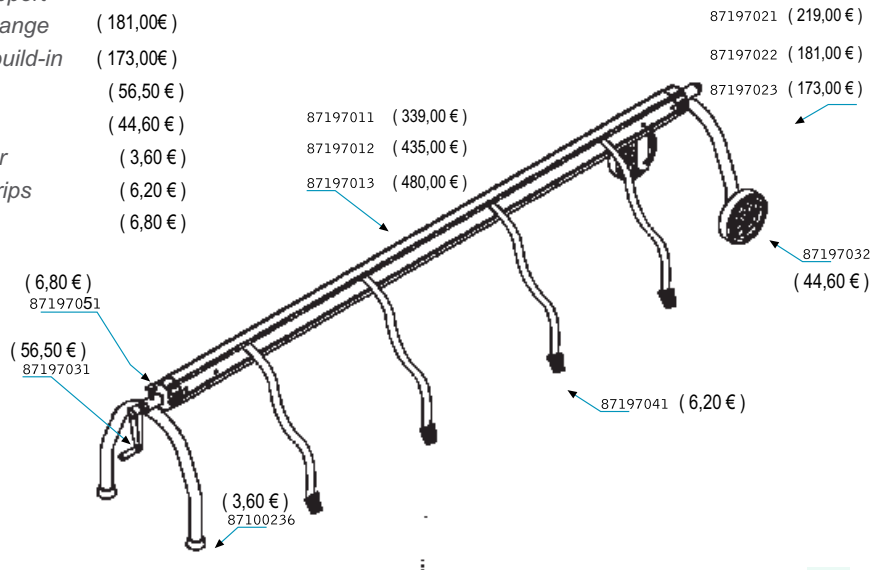



Köpük dolgulu can simidi / *Life ring styrophor*

Köpük malzemeden mamul, polyester kumaş kaplı

Dış çapı Ø 70 cm İç çap Ø 46 cm

Made of styrophor material, soft and covered with polyester canvas
Ø exterior 70 cms. Ø interior 46 cms.

Cod.	€	Kg	m ³	U
87194040	132,00	1,2	0,05	x1

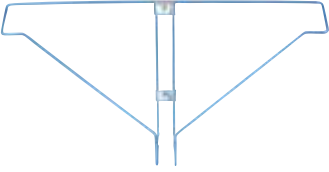

Can simidi askısı / *Life ring holder*

Cod.	€	Kg	m ³	U
87194010	60,00	0,7	0,09	x1



Can simidi askı direği / *Life ring base holder*

Cod.	€	Kg	m ³	U
87194020	93,00	2,5	0,01	x1

Ölçüler mm - Measures in mm