

# NOZBART®

*The best of the world...*

KENDİNDEN EMİŞLİ  
DENİZ SUYUNA UYGUN  
SELF-PRIMING  
SUITABLE FOR SEA WATER



## HAMSI SERİSİ



# YÜKSEK PERFORMANS KÜÇÜK BOYUTLARDA

## HIGH PERFORMANCE SMALL SIZE

### 1/4 - 1/3 - 1/2 - 3/4 - 1 HP



CE



**PARANIZI BOŞA HARCAMAYIN !**

**YÜKSEK VERİMLİ NOZBART POMPA İLE ENERJİDEN TASARRUF EDİN**

**DO NOT WASTE YOUR MONEY !**

**SAVE ENERGY WITH HIGH EFFICIENCY NOZBART PUMP**

**TÜM**



PLASTİK VE MAKİNA KALIP SANAYİ VE TİCARET LİMİTED ŞİRKETİ

Dünyanın en iyisi sizin için...  
The best of the world for you...

**KENDİNDEN EMİŞLİ  
SELF-PRIMING**

**YÜKSEK VERİMLİ  
HIGH EFFICIENCY**

**1/4 - 1/3 - 1/2 - 3/4 - 1 HP**

**Termoplastik Eksantrik Süzgeçli Salyangoz Santrifüj Pompalar**  
*Thermoplastic Centrifugal Pumps with Eccentric Pre-filter*

## Üstün Özellikleri Technical Data

- ✓ Düşük enerji kullanımı, yüksek verimli termoplastik salyangoz pompa  
*Low electrical consumption and high efficiency thermoplastic pump*
  - ✓ Yarıya kadar kirlendiğinde bile performansı düşmeyen eksantrik geçişli ön filtre **(2,5 Lt.)**  
*Easy flow large pre-filter with high performance even up to half dirty (2,5 lt.)*
- ✓ Tam dengelenmiş çark uzun motor ömrünü garanti eder  
*Full balanced impeller ensures long engine life*
  - ✓ Sessiz ve titreşimsiz, uzun ömürlü çalışma  
*Long life, no vibration, noiseless run*
- ✓ Yüzme havuzları, deniz suyu ve genel amaçlar için kullanıma uygun  
*Special design for swimming pools, sea water and general purpose*
  - ✓ Özgün tasarımlı ileri teknoloji ürünü yüksek mukavemetli termoplastik pompa çarkı  
*Special design strong structure thermoplastic pump impeller*
- ✓ Akışkanın metal yüzeye temas etmediği korozyon olmayan dizayn  
*High chemical resistance with no metal-fluid contact*
  - ✓ İleri teknoloji ürünü bakım istemeyen mekanik salmastra  
*No maintenance required for mechanical ceramic seal*
- ✓ Cam elyaf takviyeli yüksek mukavemetli, üstün kaliteli ve korozyona mukavim termoplastikten mamül  
*Made of high quality corrosion resistant thermoplastic material reinforced with fiberglass*
  - ✓ IP-55 Korumalı özel elektrik motoru, fan soğutmalı ve nemli ortamlarda çalışmaya uygun  
*Special electric motor with fan cooling, suitable to run continuously in humid environment*
- ✓ Düşük ortam sıcaklığında donmaya karşı pompa ve filtrede tahliye tapası  
*Equipped with pump against freezing under low temperature conditions with drain plug under filter and pump body*
  - ✓ Filtre kirliliğinin görüldüğü şeffaf ve yüksek mukavemetli kapak  
*Strong transparent cover to observe filter contamination*
- ✓ Bütün bağlantı elemanları paslanmaz çelik  
*All attachment parts are stainless steel*
  - ✓ Güzel ve estetik görünüm, modern ve sağlam dizayn, en ileri teknoloji  
*Nice appearance, modern and reliable design*
- ✓ Tüm Plastik'in geliştirdiği ayak bağlantı sistemi sayesinde boyutlar küçültülmüş, yüksek mukavemet, kolayca ve rahatça zemine tesbit imkanı elde edilmiştir.  
*Due to foot connection system developed by TÜR PLASTİK, dimensions are minimized; high strength, easy and convenient fixture to the ground are obtained.*
  - ✓ NOZBART pompa yüksek verimi ile kendini 6 ayda amorti eder.  
*NOZBART pump amortize itself in 6 months with high efficiency.*



⚡ 50 HZ - 2850 d/dak  
rpm

⚡ Elektrik bağlantısı; (1 Faz - 220 V) 50 Hz 2850 devir/dakika  
Electrical Connection; (1 ph -220 V) 50 Hz 2850 rpm

⚡ Diğer voltaj ve frekanslarda pompalar üretilmektedir.  
Special voltages and frequencies are manufactured on request

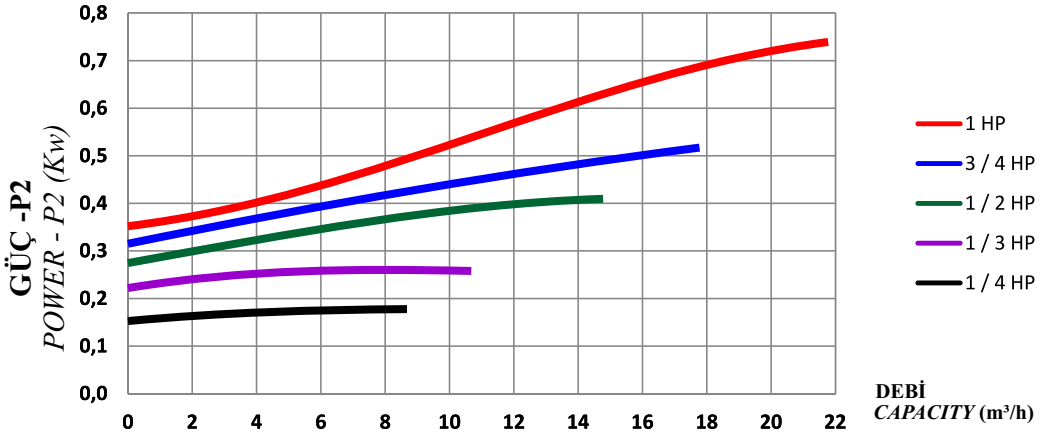
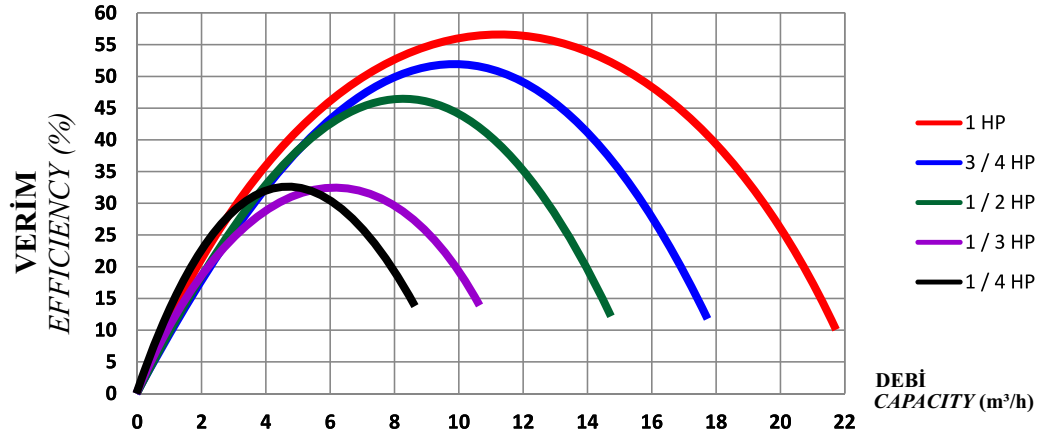
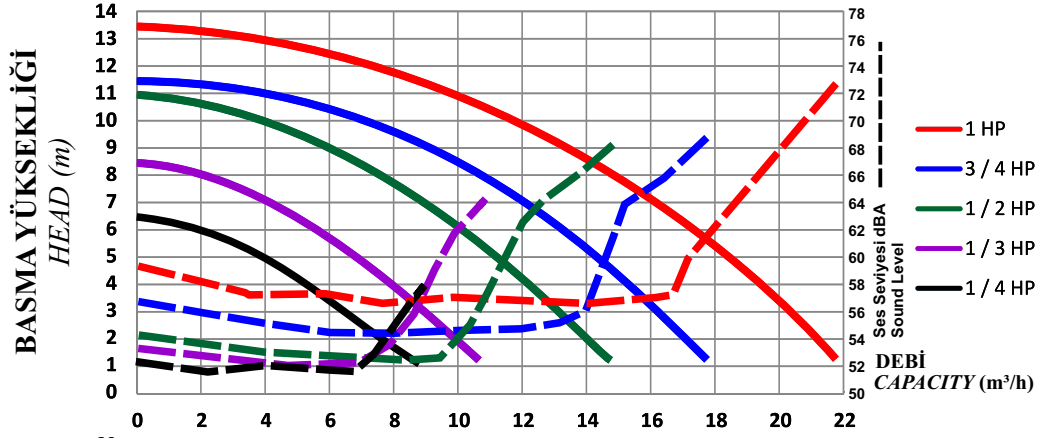

Pompa eğrileri, TSE EN ISO 9906 standartlarına uygundur.  
Pump curves are convenient to TSE EN ISO 9906 standards.

### GERÇEK TEST VERİLERİDİR REAL TEST VALUES

Özgül Ağırlık : 1 gr/cm³  
Specific Gravity

Sıcaklık : 20 °C  
Temperature

Akışkan için geçerli değerlerdir.  
Current values for fluid

GÜÇ POWER	BASMA YÜKSEKLİĞİ - HEAD (m)					
	2	4	6	8	10	12
DEBİ - CAPACITY (m³/h)						
1/4 HP	7,5	5,5	2,0			
1/3 HP	9,5	8,0	5,5	2		
1/2 HP	14,0	12,0	10,0	7,5	4,0	
3/4 HP	17,0	15,0	13,0	10,5	7,0	
1 HP	21,0	19,5	17,0	15,0	11,5	7,5





Ön filtreli  
Pump with prefilter

## Wat Motor

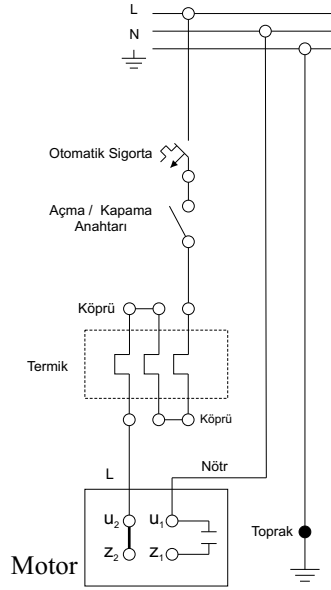

## Volt Motor

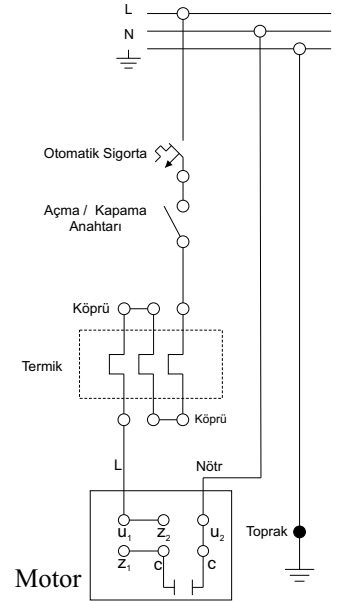

### 1/4 - 1/3 - 1/2 - 3/4 - 1 HP Monofaze Güç Şeması 1/4 - 1/3 - 1/2 - 3/4 - 1 HP Monophase Electrical Connection

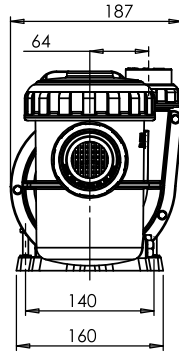
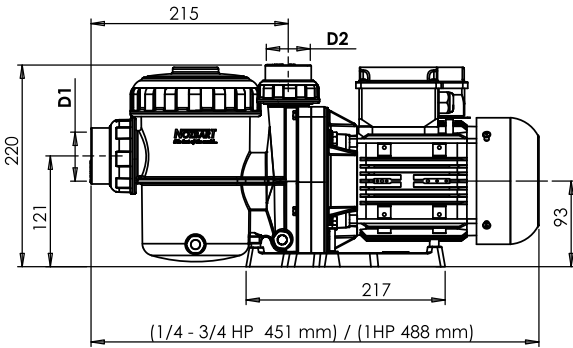

HP	METRIC ISO / DIN		IMPERIAL BS / ANSI / ASTM / AS / NZS			
	D1 mm	D2 mm	D1 inch	mm	D2 inch	mm
1/4	50	40	1½"	48,3	1¼"	42,3
1/3	50	40	1½"	48,3	1¼"	42,3
1/2	50	40	1½"	48,3	1¼"	42,3
3/4	50	40	1½"	48,3	1¼"	42,3
1	50	40	1½"	48,3	1¼"	42,3

Teknik Ölçüler (mm) / Dimensions (mm)

Güç Power	Kutulu Boxed (kg)	Kutusuz Unboxed (kg)
	Ön filtreli Pump with prefilter	Ön filtreli Pump with prefilter
	Mono	Mono
1/4 HP	7,75	7,2
1/3 HP	8,25	7,7
1/2 HP	8,75	8,2
3/4 HP	9,75	9,2
1 HP	11,75	11,2

Pompa Ağırlıkları / Pump Weights

