



duşlar su perdeleri ve jetler  
*showers water curtains and jets*



2026  
Fiyat Listesi-Price List

**NOZBART®**  
The best of the world...



**TÜM**

**TÜV  
CERT**  
DIN EN ISO 9001:2015  
Zertifikat 15 100 52993

**TSE**

**EAC CE**

**UHE**  
\* UHE Kurucu Üyesidir.\*

PLASTİK VE MAKİNA KALIP SANAYİ VE TİCARET LİMİTED ŞİRKETİ



Standart duş / *Standard shower*

Duş ayağı opsiyonel olup fiyata dahil değildir. (Cod. 87100913)  
*Optional anchor, Cod. 87100913, not included.*



Cod.	€	a	b	c	d	e	f	Kg	m <sup>3</sup>
87170049	<b>302,46</b>	387	2287	1210	-	43ø	28ø	5	0,04



Ayak yıkamalı duş / *With footwasher shower*

Duş ayağı opsiyonel olup fiyata dahil değildir. (Cod. 87100913)  
*Optional anchor, Cod. 87100913, not included.*

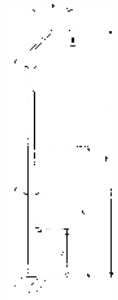

Cod.	€	a	b	c	d	e	f	Kg	m <sup>3</sup>
87170056	<b>330,86</b>	387	2287	1210	450	43ø	28ø	5	0,04



Çift başlıklı duş / *Double shower*

Duş ayağı gerektirir ve fiyata dahil değildir. (Cod. 87100939)  
*Needs anchor, Cod. 87100939, not included.*

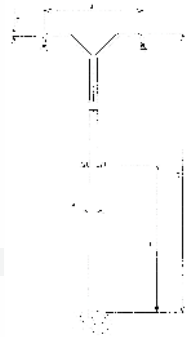

Cod.	€	a	b	c	d	e	f	Kg	m <sup>3</sup>
87170072	<b>934,36</b>	782	2288	850	-	63ø	22ø	8	0,05

Otomatik kapamalı / *With close automatically*

Cod.	€	a	b	c	d	e	f	Kg	m <sup>3</sup>
87170073	<b>1.368,88</b>	782	2288	850	1050	63ø	22ø	8	0,05

### Otomatik kapamalı duş / Shower with close automatically

Duş ayağı gerektirir ve fiyata dahil değildir. (Cod. 87100939)  
Needs anchor; Cod. 87100939, not included.

Cod.	€	a	b	c	d	e	f	Kg	m <sup>3</sup>
87170064	<b>654,62</b>	387	2287	1210	-	63ø	28ø	8	0,05

Ayak yıkamalı / With footwasher

Cod.	€	a	b	c	d	e	f	Kg	m <sup>3</sup>
87170065	<b>1.121,80</b>	387	2287	1210	450	63ø	28ø	8	0,05

### Güneş ısıtım duş / Solar shower

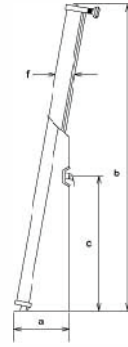

Cod.	€	a	b	c	d	e	f	Kg	m <sup>3</sup>
87170090	<b>2.339,45</b>	700	2287	1100	-	-	290	40	0,60

### Güneş ısıtım duş (Helios) Solar Helios

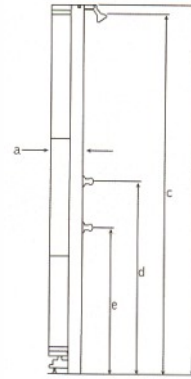

Cod.	€	a	b	c	d	e	Kg	m <sup>3</sup>
87170091	<b>1.154,46</b>	195	2203	2120	1150	875	22	0,14

Duş ayağı  
Anchor shower



Duş ayağı kolay montaj ve demontaj sağlar  
Anchor which allows an easy assembling / dismantling.

Cod.	€	ø	Kg	m <sup>3</sup>	U
87100913	49,70	43	0,98	0,0033	x1
87100939	73,84	63	0,98	0,0033	x1



Duş ayak kapağı  
Cover anchor shower

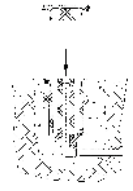

Cod.	€	Kg	m <sup>3</sup>	U
87100947	35,50	0,1	0,001	x1

Mini Bali su perdesi / Water curtain Mini Bali



Debi / Flow : 20 m<sup>3</sup>/h  
Ayak gerektiririz / Anchor not needed  
Erkek bağlantı / Female connection : 1 1/2"

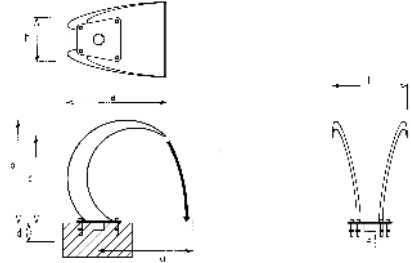

Cod.	€	a	b	c	d	e	f	g	h	Kg	m <sup>3</sup>
87185041	1.158,72	467	480	395	62	1 1/2" G	350	1000	204	14	0,086

Mai su perdesi / Water curtain Maui

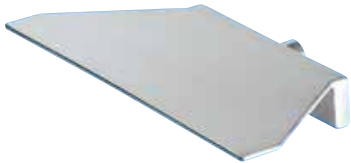

Debi / Flow : 20 - 10 - 35 m<sup>3</sup>/h  
Dişi bağlantı / Female connection : 1"

**AISI 316**

Cod.	€	a	b	c	Kg	m <sup>3</sup>
87186060	842,06	62	500	220	4	0,0036
87186061	651,78	62	300	220	3	0,0018
87186065	1.437,04	62	1000	250		

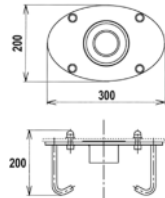
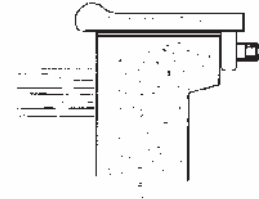

Su jeti ayağı / Anchor for cannon jet Fidji

**AISI 316**

Dişi bağlantı / Female connection : 2"

Cod.	€	Kg	m <sup>3</sup>
87185039	441,62	3,25	0,018

### Bali su perdesi / Water curtain Bali

Debi / Flow : 30 m<sup>3</sup>/h  
Ayak gerektirir / Needs anchor

**AISI 316**

Cod.	€		a	b	c	d	e	f	Kg	m <sup>3</sup>
87185047	2.159,82	Parlak	673	688	567	500	245	124	24,8	0,28
87185054	2.074,62	Mat	673	688	567	500	245	124	24,8	0,28

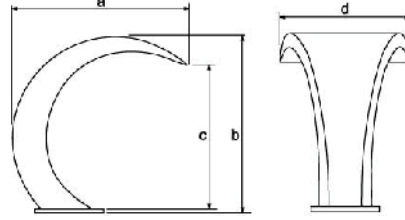

87185047

**Parlak**

Brillo  
Polished  
Polie

87185054

**Mat**

Mate  
Brush polished  
Mat

### Su perdesi ayağı / Anchor for water curtain Bali

Dişi bağlantı / Female connection : 2"

**AISI 316**

Cod.	€	a	b	c	d	Kg	m <sup>3</sup>
87185062	529,66	200	300	300	45	4,25	0,018

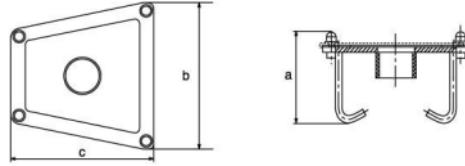

### Bali su perdesi / Water curtain Bali

- 87185047 Su perdesi parlak / Water curtain Polished ( 2.159,82 € )
- 87185054 Su perdesi mat / Water curtain brush polished ( 2.074,62 € )
- 87185062 Su perdesi ayağı / Anchor for water curtain ( 529,66 € )

87185047  
( 2.159,82 € )  
87185054  
( 2.074,62 € )

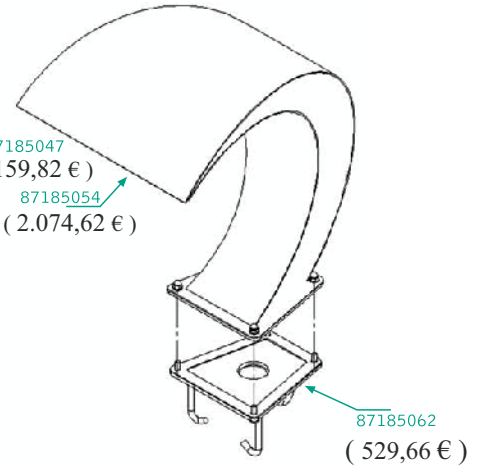

### Su perdesi muhafazası / Escutcheon Bali curtain

**AISI 316**

Cod.	€		Descr.	Kg	m <sup>3</sup>
87185048	316,66	Parlak	Brillo	2	0,0006
87185055	302,46	Mat	Mate	2	0,0006





Tahiti su jeti / Cannon jet Tahiti

Debi / Caudal / Flow / Débit: 6 m<sup>3</sup>/h  
Ayak gerektirmez / No necesita anclaje / No needs anchors / N'a pas besoin de l'ancrage.  
Erkek bağlantı / Rosca macho / Male connection / Embranchement mâle: 1 1/2"  
ø43 mm

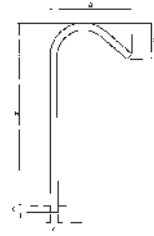

**AISI 316**

Cod.	€	a	b	c	d	e	Kg	m <sup>3</sup>
87187010	<b>265,54</b>	482	1100	40	217	1 1/2"	4,6	0,06



Nozzle A

**AISI 316**

Cod.	€	Kg	m <sup>3</sup>
87187014	<b>156,20</b>	0,42	0,003



Nozzle B

**AISI 316**

Cod.	€	Kg	m <sup>3</sup>
87187012	<b>130,64</b>	0,39	0,003



Nozzle C

**AISI 316**

Cod.	€	Kg	m <sup>3</sup>
87187011	<b>186,02</b>	0,5	0,003



Nozzle D

**AISI 316**

Cod.	€	Kg	m <sup>3</sup>
87187013	<b>194,54</b>	0,58	0,003

### Su jeti dairesel / Cannon jet Fidji circular

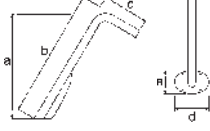

Debi / Flow : 6 m<sup>3</sup>/h  
Ø63 mm

**AISI 316**

Cod.

€

○ 87185014	<b>876,14</b>	Parlak / Polished
○ 87185015	<b>790,94</b>	Mat / Brush polished



### Su jeti düz / Cannon jet Fidji flat

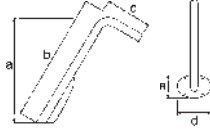

Debi / Flow : 6 m<sup>3</sup>/h  
Ø63 mm

**AISI 316**

Cod.

€

○ 87185022	<b>985,48</b>	Parlak / Polished
○ 87185023	<b>911,64</b>	Mat / Brush polished



### Düz nozul / Flat nozzle

**AISI 316**

Cod.

€

Kg

m<sup>3</sup>

○ 87185088	<b>248,64</b>	2,5	0,018
------------	---------------	-----	-------

### Dairesel nozul / Circular nozzle

**AISI 316**

Cod.

€

Kg

m<sup>3</sup>

87185070	<b>151,23</b>	1,0	0,003
----------	---------------	-----	-------

